

A Smarter Vision®

## PHOTOELECTRIC TYPE SINGLE STATION/MULTI-STATION SMOKE ALARMS, AC POWERED, WITH BATTERY BACK-UP, 120VAC/9VDC, 60HZ OR 220VAC/9VDC, 50/60HZ & TANDEM WIRE CONNECTION

### Installation Instructions - Owner's Information READ CAREFULLY AND SAVE

#### INTRODUCTION 9000 SERIES

The 9123 and 9223 Series smoke alarm is a photoelectric type unit for use as an evacuation device in residential and commercial residential applications. Each smoke alarm has a solid state piezo signal to warn and alert the household to the presence of threatening smoke.

Your photoelectric smoke alarm is designed to detect the smoke that results from an actual fire. Consequently, it is uncommon for household smoke such as cigarette smoke or normal cooking smoke to cause an alarm.

#### BASIC SAFETY INFORMATION

Dangers, Warnings, Cautions and Notices alert you to important operating procedures or to potentially hazardous situations. Pay special attention to these items.

#### WARNING

- This photoelectric smoke alarm is listed for use in single-family and multi-family residences, along with hotels, motels and other commercial residential occupancies.
- This photoelectric smoke alarm must receive continuous 120VAC, 60Hz, pure sine wave electrical power (battery is meant for emergency back-up only). In order for the emergency battery back-up to work, a new battery must be properly installed (see BATTERY INSTALLATION section).
- NEVER ignore your smoke alarm if it sounds. Refer to IF YOUR SMOKE ALARM SOUNDS section for more information. Failure to do so can result in serious injury or death.
- Test this device once a week per manufacturer installation recommendation. If the device ever fails to test correctly, replace immediately! If the device is not working properly, it can not alert you to a problem.
- This product is intended for use in indoor locations of family dwelling units.

#### MODELS

(SEE BACK OF SMOKE ALARM FOR EXACT MODEL)

- \* 9123.....120VAC, 60Hz with temporal 3 horn
- \* 9223.....220VAC, 50/60Hz with temporal 3 horn

\* Per NFPA 72, the American National Standard Audible Emergency Evacuation Signal as defined in ANSI S3.41, is required whenever the intended response is to evacuate the building.

#### OPTIONS, SELECTIONS:

- T - Integral 135°F Thermal Sensor
- H - Isolated 135°F Thermal Sensor
- F - 1 Form A/1 Form C Auxiliary Relay

NOTICE: IN THE EVENT AC POWER FAILS, A 9VDC BATTERY WILL PROVIDE PROPER ALARM OPERATION FOR A MINIMUM OF 24 HOURS.

#### ELECTRICAL SPECIFICATIONS

OPERATING VOLTAGE.....	120VAC, 60Hz
OPERATING CURRENT (MAX.) (120VAC/9VDC).....	0.070 amps
OPERATING VOLTAGE.....	220VAC, 50/60Hz
OPERATING CURRENT (MAX.) (220VAC).....	0.046 amps
OPERATING AMBIENT TEMPERATURE RANGE.....	40°F to 100°F
ALARM HORN RATING.....	meets or exceeds 85 dBA at 10 feet

#### HOW YOUR SMOKE ALARM WORKS

The 9000 Series smoke alarm operates on the photoelectric light scatter principle. The unit's sensing chamber houses a light source and a light sensor.

The darkened sensing chamber is exposed to the atmosphere and designed to permit optimum smoke entry from any direction while rejecting light from outside the smoke alarm.

The light source is an infrared (invisible) LED which pulses every 8 seconds. The light sensor is a photodiode matched to the light frequency of the LED light source.

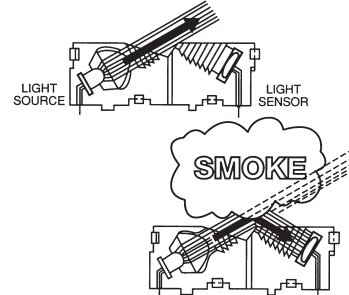

Under normal conditions, the light generated by the pulsing infrared LED is not seen by the light sensor, as it is positioned out of the direct path of the light beam. When smoke enters the sensing chamber, light from the pulsing LED light source is reflected by the smoke particles onto the photodiode light sensor. At the first sighting of smoke, the device is put into a pre-alarm mode. This is indicated by a rapidly flashing LED on the face of the smoke alarm. Once the light sensor confirms smoke for 2 consecutive pulses inside the chamber, the light sensor produces the signal necessary to trigger the alarm and sound the electronic horn.

This technique of verifying the smoke condition, combined with a 5-to-1 signal-to-noise ratio, substantially reduces the possibility of nuisance alarms.

#### HOW TO TELL IF YOUR SMOKE ALARM IS WORKING PROPERLY

- Your smoke alarm is provided with an alarm horn and pulsating Light Emitting Diode (indicator) Diode, which pulses every 30 seconds, and a green AC power on LED.
- When turning the test knob on the smoke alarm to TEST 1 the red light emitting diode should flash rapidly and the horn should sound.
- If the battery is low or missing, a chirp will be emitted when the red LED flashes. If the smoke alarm is malfunctioning, the chirp will sound between the red LED flashes. If AC power fails, the green LED will turn off.
- The test knob of your smoke alarm simulates actual smoke conditions.

#### NOTE: TANDEM INTERCONNECT MODELS.

- When testing one smoke alarm, the device that is activated will flash the red indicator light and sound its alarm horn. All other units will sound the alarm horn with their red indicator lights remaining off. The relays will also activate on all units in tandem on models equipped with the relay option.

#### FIRE PROTECTION PLAN: WHAT YOU CAN DO TO MAKE YOUR FAMILY SAFE FROM FIRES

This smoke alarm can quickly alert you to the presence of smoke; it cannot prevent fire. The ultimate responsibility for fire protection rests solely on you.

Installing smoke alarms is just the first step in protecting your family from fires. You also must reduce the chances that fires will start in your home and increase your chances of safely escaping if one does start. To have an effective fire safety program:

- Install smoke alarms properly following the instructions in this manual. Keep your units clean. Test your smoke alarm weekly and have unit repaired or replace unit when it no longer functions.** As with any electronic product, smoke alarms have a limited life, and devices that don't work cannot protect you.
- Follow safety rules and prevent hazardous situations:**
  - Use smoking materials properly; never smoke in bed.
  - Keep matches and cigarette lighters away from children.
  - Store flammable materials in proper containers and never use them near open flames or sparks.
  - Keep electrical appliances and cords in good working order and do not overload electrical circuits.
  - Keep stoves, fireplaces, chimneys, and barbecue grills grease-free and make sure they are properly installed away from combustible materials.
  - Keep portable heaters and open flames such as candles away from combustible materials.
  - Do not allow rubbish to accumulate.
  - Do not leave small children home alone.

**c. Develop a family escape plan and practice it with your entire family, especially small children.**

- Draw and post a floor plan of your home and find two ways to exit from each room. There should be one way to get out of each bedroom without opening the door.
- Teach children what the smoke alarm signal means, and that they must be prepared to leave the residence by themselves if necessary. Show them how to check to see if doors are hot before opening them, how to stay close to the floor and crawl if necessary, and how to use the alternate exit if the door is hot and should not be opened.
- Decide on a meeting place a safe distance from your house and make sure that all your children understand that they should go and wait for you if there is a fire.
- Hold fire drills at least every 6 months to make sure that everyone, even small children, know what to do to escape safely.
- Know where to go to call the fire department from outside your residence.
- Provide emergency equipment such as fire extinguishers and teach your family to use this equipment properly.

**d. Bedroom doors should be closed while sleeping if a smoke alarm is installed in the bedroom.** They act as a barrier against heat and smoke.

**WHAT TO DO IF THERE IS A FIRE IN YOUR HOME**

If you have prepared family escape plans and practiced them with your family, you have increased their chances of escaping safely. Review the following rules with your children when you have fire drills so everyone will remember them in a real fire emergency. If the alarm should sound:

- a. Don't panic; stay calm. Your safe escape may depend on thinking clearly and remembering what you have practiced.
- b. Get out of the house following a planned escape route as quickly as possible. Do not stop to collect anything or to get dressed.
- c. Open doors carefully only after feeling to see if they are hot. Do not open a door if it is hot; use an alternate escape route.
- d. Stay close to the floor; smoke and hot gases rise.
- e. Cover your nose and mouth with a cloth, wet if possible, and take short, shallow breaths.
- f. Keep doors and windows closed unless you open them to escape.
- g. Meet at your prearranged meeting place after leaving the house.
- h. Call the Fire Department as soon as possible from outside your house. Give the address and your name.
- i. Never re-enter a burning building.

Contact your local Fire Department for more information on making your home safer from fires and about preparing your family's escape plans.

**NOTICE:** CURRENT STUDIES HAVE SHOWN SMOKE ALARMS MAY NOT AWAKEN ALL SLEEPING INDIVIDUALS, AND THAT IT IS THE RESPONSIBILITY OF INDIVIDUALS IN THE HOUSEHOLD THAT ARE CAPABLE OF ASSISTING OTHERS TO PROVIDE ASSISTANCE TO THOSE WHO MAY NOT BE AWAKENED BY THE ALARM SOUND, OR TO THOSE WHO MAY BE INCAPABLE OF SAFELY EVACUATING THE AREA UNASSISTED.

**WHAT THIS SMOKE ALARM CAN DO**

This smoke alarm is designed to sense smoke entering its sensing chamber. It does not sense gas, heat (except for the H or T options), or flames.

When properly located, installed, and maintained, this smoke alarm is designed to provide early warning of developing fires at a reasonable cost. This unit monitors the air and, when it senses smoke, activates its built-in alarm horn. It can provide precious time for you and your family to escape from your residence before a fire spreads. Such an early warning, however, is possible only if the smoke alarm is located, installed, and maintained as specified in this User's Manual.

**NOTICE:** THIS SMOKE ALARM IS DESIGNED FOR USE WITHIN SINGLE RESIDENTIAL LIVING UNITS ONLY; THAT IS, IT SHOULD BE USED INSIDE A SINGLE-FAMILY HOME OR ONE APARTMENT OF A MULTI-FAMILY BUILDING. IN A MULTI-FAMILY BUILDING, THE DEVICE MAY NOT PROVIDE EARLY WARNING FOR RESIDENTS IF IT IS PLACED OUTSIDE OF THE RESIDENTIAL UNITS, SUCH AS ON OUTSIDE PORCHES, IN CORRIDORS, LOBBIES, BASEMENTS, OR IN OTHER APARTMENTS. IN MULTI-FAMILY BUILDINGS, EACH RESIDENTIAL UNIT SHOULD HAVE SMOKE ALARMS TO ALERT THE RESIDENTS OF THAT UNIT. UNITS DESIGNED TO BE INTERCONNECTED SHOULD BE INTERCONNECTED WITHIN ONE FAMILY RESIDENCE ONLY; OTHERWISE, NUISANCE ALARMS WILL OCCUR WHEN A SMOKE ALARM IN ANOTHER LIVING UNIT IS TESTED.

**NOTICE: WHAT SMOKE ALARMS CANNOT DO**

**Smoke alarms will not work without power.** A battery must be connected to the device to maintain proper alarm operation if device AC power supply is cut off by an electrical fire, an open fuse or circuit breaker, or for any other reason. In the event of AC power failure, the battery will supply power for a minimum of 24 hours.

**Smoke alarms may not sense fire that starts where smoke cannot reach the devices** such as in chimneys, in walls, on roofs, or on the other side of closed doors. If bedroom doors are usually closed at night, smoke alarms should be placed in each bedroom as well as in the common hallway between them.

**Smoke alarms also may not sense a fire on another level of a residence or building.** For example, a second-floor device may not sense a first-floor or basement fire. Therefore, **smoke alarms should be placed on every level of a residence or building.**

The horn in your smoke alarm meets or exceeds current audibility requirements of ANSI/UL 217. However, if the **smoke alarm is located outside a bedroom, it may not wake up a sound sleeper**, especially if the bedroom door is closed or only partly open. If the smoke alarm is located on a different level of the residence than the bedroom, it is even less likely to awaken people sleeping in the bedroom. In such cases, the National Fire Protection Association recommends that smoke alarms be interconnected so that a unit on any level of the residence will sound an alarm loud enough to awaken sleepers in closed bedrooms. This can be done by employing a systematic approach by interconnecting smoke alarms together, or by using radio frequency transmitters and receivers.

**All types of smoke alarm sensors have limitations. No type of device can sense every kind of fire every time. In general, smoke alarms may not always warn you about fires caused by violent explosions, escaping gas, improper storage of flammable materials, or arson.**

**NOTICE:** THIS SMOKE ALARM IS NOT DESIGNED TO REPLACE SPECIAL-PURPOSE FIRE DETECTION AND SMOKE ALARM SYSTEMS NECESSARY TO PROTECT PERSONS AND PROPERTY IN NON-RESIDENTIAL BUILDINGS SUCH AS WAREHOUSES, OR OTHER LARGE INDUSTRIAL OR COMMERCIAL BUILDINGS. IT ALONE IS NOT A SUITABLE SUBSTITUTE FOR COMPLETE FIRE-DETECTION SYSTEMS DESIGNED TO PROTECT INDIVIDUALS IN HOTELS AND MOTELS, DORMITORIES, HOSPITALS, OR OTHER HEALTH AND SUPERVISORY CARE AND RETIREMENT HOMES. PLEASE REFER TO NFPA 101, THE LIFE SAFETY CODE, AND NFPA 72 FOR SMOKE ALARM REQUIREMENTS FOR FIRE PROTECTION IN BUILDINGS NOT DEFINED AS "HOUSEHOLDS."

Installing smoke alarms may make you eligible for lower insurance rates, but **smoke alarms are not a substitute for insurance.** Home owners and renters should continue to insure their lives and property.

**PLACEMENT OF SMOKE ALARMS**

THIS EQUIPMENT SHOULD BE INSTALLED IN ACCORDANCE WITH THE NATIONAL FIRE PROTECTION ASSOCIATION'S STANDARD 72 (National Fire Protection Association, Batterymarch Park, Quincy, MA 02269).

For your information, the National Fire Protection Association's Standard 72, reads as follows:

NFPA 72, 2013 Edition, Chapter 29, Section 29.5.1.1 Where required by applicable laws, codes or standards for a specific type of occupancy, approved single and multiple-station smoke alarms shall be installed as follows:

**29.5.1.1** Where required by applicable laws, codes or standards for a specific type of occupancy, approved single and multiple-station smoke alarms shall be installed as follows:

- 1) In all sleeping rooms and guest rooms
- 2) Outside of each separate dwelling unit sleeping area, within 6.4m (21ft) of any door to a sleeping room, the distance measured along a path of travel
- 3) On every level of a dwelling unit, including basements
- 4) On every level of a residential board and care occupancy (small facility), including basements and excluding crawl spaces and unfinished attics
- 5) In the living area(s) of a guest suite
- 6) In the living area(s) of a residential board and care occupancy (small facility)

**29.5.1.2** Where the area addressed in 29.5.1.1(2) is separated from the adjacent living areas by a door, a smoke alarm shall be installed in the area between the door and the sleeping room, and additional alarms shall be installed on the living area side of the door as specified by 29.5.1.1 and 29.5.1.3.

**29.5.1.3** In addition to the requirements of 29.5.1.1(1) through 29.5.1.1(3), where the interior floor area for a given level of a dwelling unit, excluding garage areas, is greater than 93m<sup>2</sup> (1000ft<sup>2</sup>), smoke alarms shall be installed per 29.5.1.3.1 and 29.5.1.3.2.

**29.5.1.3.1** All points on the ceiling shall have a smoke alarm within a distance of 9.1m (30ft) travel distance or shall have an equivalent of one smoke alarm per 46.5m<sup>2</sup> (500ft<sup>2</sup>) is evaluated by dividing the total interior square footage of floor area per level by 46.5m<sup>2</sup> (500ft<sup>2</sup>).

**29.5.1.3.2** Where dwelling units include great rooms or vaulted/cathedral ceilings extending over multiple floors, smoke alarms located on the upper floor that are intended to protect the aforementioned area shall be permitted to be considered as part of the lower floor(s) protection scheme used to meet the requirements of 29.5.1.3.1.

The installation of additional alarms of smoke, heat or CO type should result in a higher degree of protection. Adding alarms to rooms that are normally closed off from the required alarms increases the escape time because the fire does not need to build to the higher level necessary to force smoke out of the closed room to the required alarms. As a consequence, it is recommended that the householder consider the installation of additional fire protection devices. However, it should be understood that NFPA 72 does not require additional smoke alarms over and above those called for in FIGURES 1, 2, 3 and 4 where required smoke alarms are shown.

FIGURE 1

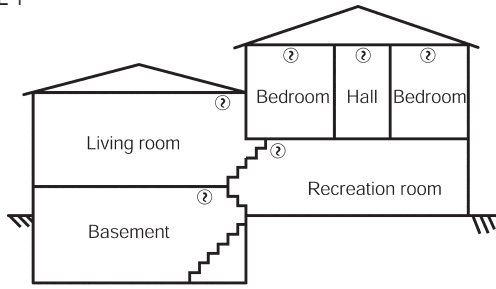

② Indicates required smoke alarm

FIGURE 1: A SMOKE ALARM SHOULD BE LOCATED ON EVERY LEVEL OF DWELLING UNIT, INCLUDING BASEMENT, WITHIN EACH SLEEPING ROOM AND OUTSIDE SLEEPING AREAS.

*Where to Locate the Required Smoke Alarms.* The major threat from fire in a dwelling unit occurs at night when everyone is asleep. Persons in sleeping areas can be threatened by fires in the remainder of the unit; therefore, smoke alarms are best located in each bedroom and between the bedroom areas and the rest of the unit as shown in FIGURE 2.

FIGURE 2

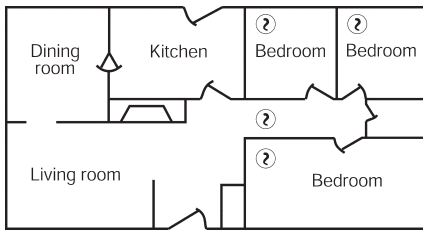

FIGURE 2: A SMOKE ALARM SHOULD BE LOCATED BETWEEN THE SLEEPING AREA AND THE REST OF THE DWELLING UNIT AS WELL AS IN EACH BEDROOM.

In dwelling units with more than one bedroom area or with bedrooms on more than one floor, more than one smoke alarm is required, as shown in FIGURE 3.

FIGURE 3

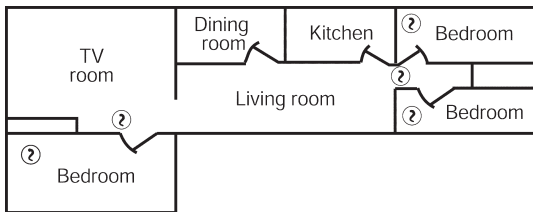

FIGURE 3: IN DWELLING UNITS WITH MORE THAN ONE SLEEPING AREA, A SMOKE ALARM SHOULD BE PROVIDED TO PROTECT EACH SLEEPING AREA IN ADDITION TO SMOKE ALARMS REQUIRED IN BEDROOMS.

In addition to smoke alarms outside of the sleeping areas and in each bedroom, NFPA 72 requires the installation of a smoke alarm on each additional level of the dwelling unit, including the basement. These installations are shown in FIGURE 4. The living area smoke alarm should be installed in the living room or near the stairway to the upper level, or in both locations. The basement smoke alarm should be installed in close proximity to the stairway leading to the floor above. Where installed on an open-joisted ceiling, the smoke alarm should be placed on the bottom of the joists. The smoke alarm should be positioned relative to the stairway so as to intercept smoke coming from a fire in the basement before the smoke enters the stairway.

FIGURE 4

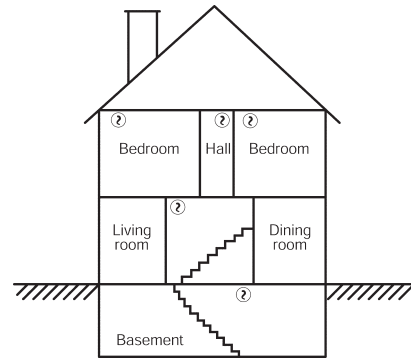

Figure 4: A SMOKE ALARM SHOULD BE LOCATED ON EACH LEVEL IN ADDITION TO EACH BEDROOM.

*Are More Smoke Alarms Desirable?* The required number of smoke alarms might not provide reliable early warning protection for those areas separated by a door from the areas protected by the required smoke alarms. For this reason, the use of additional smoke alarms for those areas for increased protection is recommended. The additional areas include the basement, bedrooms, dining room, furnace room, utility room, and hallways not protected by the required smoke alarms. The installation of smoke alarms in kitchens, attics (finished or unfinished), or garages is not normally recommended, because these locations occasionally experience conditions that can result in improper operation.

**IMPORTANT CONSIDERATION**

NFPA 72, 2013 Edition, Chapter 29, Section 29.8.1.4(5)(b) states: "Smoke alarms installed in one- and two-family dwellings shall not remain in service longer than 10 years from the date of manufacture." Smoke alarms should be replaced for the following reasons:

- Dust, dirt, and other environmental contaminants can affect your smoke alarm over a prolonged period.
- Fast changing industry consensus standards and codes on all smoke alarms make it advisable to periodically upgrade your devices to maximize life safety.
- Assurance that your smoke alarm needs are kept abreast with the constantly improving electronic technology.
- Smoke alarms are recognized as one of the lowest cost ways to protect dwelling inhabitants against the danger of fire(s). It makes good common sense to periodically replace and update your smoke alarm that contributes so much to life safety.

**MOUNTING LOCATION**

This smoke alarm can be mounted on a ceiling or wall with equal efficiency in either location.

- Ceiling location - smoke alarm should be mounted as close as possible to the center of a hallway or room.
- Wall location - locate the top of the smoke alarm not more than 12 inches from the ceiling.

FIGURE 5



FIGURE 5: RECOMMENDED SMOKE ALARM MOUNTING LOCATIONS

Figures 1, 2, 3, & 4 are reprinted with permission from NFPA 72, National Fire Alarm Code®, Copyright ©2002, National Fire Protection Association, Quincy, MA 02169. This reprinted material is not the complete and official position of the National Fire Protection Association on the referenced subject which is represented only by the standard in its entirety. National Fire Alarm Code® and NFPA 72® are registered trademarks of the National Fire Protection Association, Inc., Quincy, MA 02169.



FIGURE 6

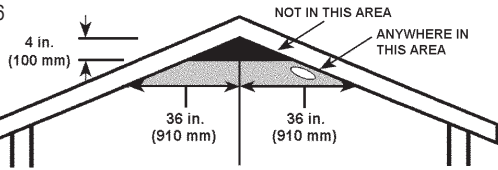

FIGURE 6: RECOMMENDED SMOKE ALARM LOCATION IN ROOMS WITH SLOPED, GABLED, OR PEAKED CEILINGS.

The placement of the smoke alarm is critical if maximum speed of fire detection is desired. Thus, a logical location for a smoke alarm is the center of the ceiling. At this location, the device is closest to all areas of the room.

**WHERE SMOKE ALARMS SHOULD BE INSTALLED IN MOBILE HOMES**

In mobile homes built after about 1978 that were designed and insulated to be energy-efficient, smoke alarms should be installed as described in the section above.

In older mobile homes that have little or no insulation compared to today's standards, uninsulated metal outside walls and roofs can transfer heat and cold from outdoors, making the air right next to them hotter or colder than the rest of the inside air. These layers of hotter or colder air can prevent smoke from reaching a smoke alarm. Therefore, install smoke alarms in such units only on inside walls not more than 12 inches (30 cm) from the ceiling. If you are not sure about the insulation level in your mobile home, or if you notice that the walls or ceiling are unusually hot or cold, install the smoke alarm on an inside wall.

Minimum protection requires one smoke alarm as close to the sleeping area as possible. For better protection, install one smoke alarm in each room, but first read the "Locations to Avoid."

**LOCATIONS TO AVOID**

Nuisance alarms are caused by placing smoke alarms where they will not operate properly. To avoid nuisance alarms, **do not place smoke alarms:**

- **In or near areas where combustion particles are normally present** such as **kitchens**; in **garages** where there are particles of combustion in vehicle exhausts; **near furnaces, hot water heaters, or gas space heaters**. Install smoke alarms at least 20 feet (6 meters) away from kitchens and other areas where combustion particles are normally present.
- **In air streams passing by kitchens.** FIGURE 7 shows how a smoke alarm can be exposed to combustion particles in normal air movement paths, and how to correct this situation.

FIGURE 7

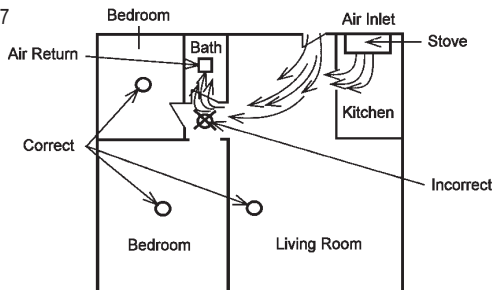

- **In damp or very humid areas**, or next to bathrooms with showers. The moisture in humid air can enter the sensing chamber as water vapor, then cool and condense into droplets that cause a nuisance alarm. **Install smoke alarms at least 10 feet (3 meters) away from bathrooms.**
- **In very cold or very hot environments, or in unheated buildings or outdoor rooms**, where the temperature can go below or above the operating range of the smoke alarm. Temperature limits for proper operation are 40° to 100°F (4.4° to 37.8°C).
- **In very dusty or dirty areas.** Dust and dirt can build up on the smoke alarm's sensing chamber and can make it overly sensitive, or block openings to the sensing chamber and keep the device from sensing smoke.
- **Near fresh air inlets, returns or excessively drafty areas.** Air conditioners, heaters, fans, and fresh air intakes and returns can drive smoke away from smoke alarms, making the devices less effective.
- **In dead air spaces at the top of a peaked roof or in the corners between ceilings and walls.** Dead air may prevent smoke from reaching a smoke alarm. See FIGURES 5 and 6 for recommended mounting locations.
- **In insect-infested areas.** If insects enter a smoke alarm's sensing chamber, they may cause a nuisance alarm. **Get rid of the bugs before installing smoke alarms where bugs are a problem.**
- **Near fluorescent light fixtures.** Electrical "noise" from nearby fluorescent light fixtures may cause a nuisance alarm. **Install smoke alarms and fluorescent lights on separate electrical circuits.**

**WARNING** Never disconnect an AC smoke alarm to silence a nuisance alarm. Open a window or fan the air around the unit to remove the smoke. The smoke alarm will automatically turn off when the smoke in the air is completely gone. Do not stand close to the unit. The sound produced by the device is loud because it is designed to awaken you in an emergency. Prolonged exposure to the horn at a close distance may be harmful to your hearing.

**INSTALLATION 9000 SERIES**

**CAUTION:** New Construction: DO NOT attach smoke alarm head until AFTER sanding, painting, and other dust creating situations are finished and cleaned up.

**WIRING/GENERAL**

1. Use ANSI/UL Listed cable with Class 1 insulation.
2. Observe local code requirements. Use box connector to anchor cable to outlet box.
3. Metal outlet boxes must be grounded to earth ground.
4. **NOTICE:** USE ONLY DURACELL® MN 1604 BATTERY WITH THE 9000 SERIES SMOKE ALARMS. AVAILABLE AT MANY RETAIL STORES.

**CAUTION:** Turn off electricity to prevent SHOCK and damage to smoke alarm. Be sure the power line to the unit is not controlled by any on/off switch, or other type of switch, other than a fuse or circuit breaker.

**IMPORTANT:** Insure that all fluorescent lighting fixtures are properly grounded.

**NOTICE:** SMOKE ALARM INSTALLATION MUST CONFORM TO THE ELECTRICAL CODES IN YOUR AREA AND TO ARTICLE 760 OF THE U.S. NATIONAL ELECTRICAL CODE. WIRE INSTALLATION SHOULD BE PERFORMED ONLY BY A LICENSED ELECTRICIAN.

**MOUNTING OUTLET BOX**

Use a 2" x 3" switch box or a 4" square or octagon junction box. Mount a box for each smoke alarm. If wall mounting is desired, be sure the box screws are oriented to upper right and lower left corners. Be sure to use supplied Mounting Plate.

**NOTICE:** FOR TROUBLE AREAS WHERE THERE CAN BE A LARGE VOLUME OF AIR BLOWING OUT THROUGH THE ELECTRICAL JUNCTION BOX. YOU MUST FIRST INSERT THE CARDBOARD SHIELD PACKAGED WITH YOUR SMOKE ALARM TO THE BACKSIDE OF DEVICE BEFORE SECURING IT TO THE MOUNTING PLATE.

**WIRING ONE SMOKE ALARM**

1. Run a minimum of 16 gauge, 2-conductor cable, plus ground (3 wires) to the junction box from a power supply. Smoke alarms shall be connected to their own dedicated circuit. Use ANSI/UL Listed Class 1 wire.
2. Make wire connections to the supplied plug-in connector as follows: black to black, white to white, and connect the ground wire to the metal outlet box.

**NOTICE:** THE WIRING TO BE USED SHALL BE IN ACCORDANCE WITH THE PROVISIONS OF ARTICLE 300.3(B) OF THE NATIONAL ELECTRICAL CODE, NFPA 70, AS WELL AS ARTICLE 210.

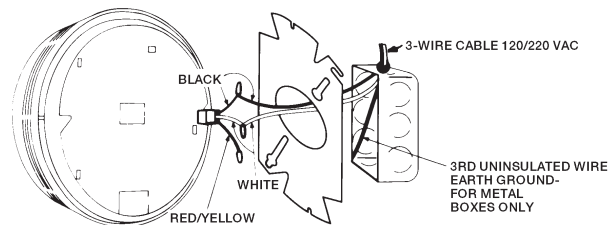

**NOTICE:** RED-YELLOW WIRE: THE RED-YELLOW WIRE FROM THE SMOKE ALARM IS FOR TANDEM CONNECTION ONLY. DO NOT USE, AND DO NOT REMOVE INSULATION CAP UNLESS CONNECTING ANOTHER SMOKE ALARM.

**Smoke Alarm Wiring Diagram**

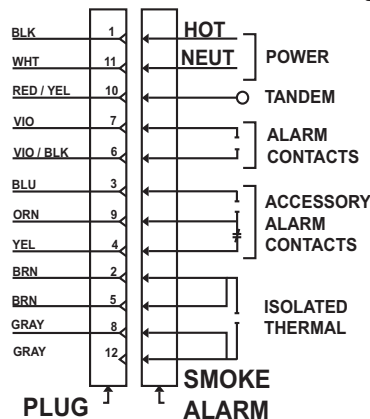

**CAUTION**  
RED/YELLOW wire to be capped when not in use. This wire is for tandem connection only. Do not connect to any other circuit.

**RATED LOAD RESISTIVE**  
1.0 AMP @ 24VDC MAX  
0.6 AMP @ 125VAC MAX  
0.56 AMP @ 220VAC MAX

## WIRING TWO OR MORE SMOKE ALARMS

### Tandem Installation

**NOTICE:** ALL SMOKE ALARMS IN A TANDEM INSTALLATION MUST BE CONTROLLED BY THE SAME FUSE OR CIRCUIT BREAKER. OTHERWISE TANDEM UNITS WILL NOT OPERATE. TANDEM WILL OPERATE IN THE EVENT OF AC POWER FAILURE IF BATTERY IS CONNECTED TO THE SMOKE ALARM.

**LIMITATIONS:** A maximum of 12 smoke alarms (9123 or 9223) may be connected together. Do not exceed 125 feet between each smoke alarm. Do not exceed 1125 feet between first and last smoke alarm.

**NOTICE:** A MAXIMUM OF SIX (6) SMOKE ALARMS OF EITHER MODEL 9123 OR 9223 WITH THE RELAY OPTIONS (F, TF, HF) MAY BE TANDEM INTERCONNECTED.

Wire used for interconnection shall be in accordance with article 760 of the latest edition of National Electrical Code (NFPA 70) and must not exceed a resistance of 10 ohms.

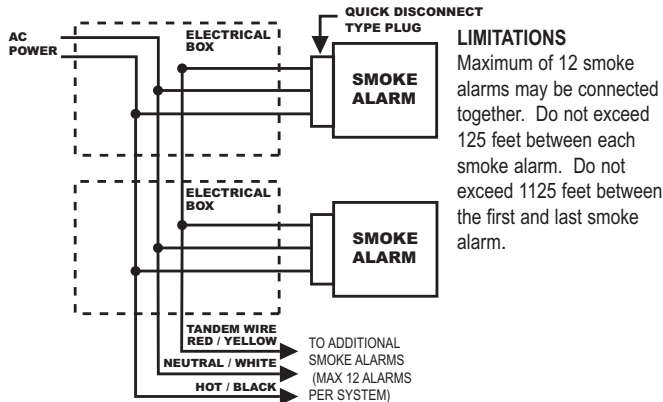

- Run a minimum of 16 gauge, 3-conductor cable, plus ground (4 wires) to the first alarm junction box from a power supply and between all smoke alarms that are to be connected together. Use ANSI/UL Listed Class 1 wire. Power limited cable for multiple tandem connections are available at many commercial electrical retail stores.
- Make wire connections to the supplied plug-in connector as follows: black to black, white to white, 3rd conductor to the red/yellow wire. The red/yellow wire should be stripped to make the connection. Connect ground wire between metal outlet boxes.

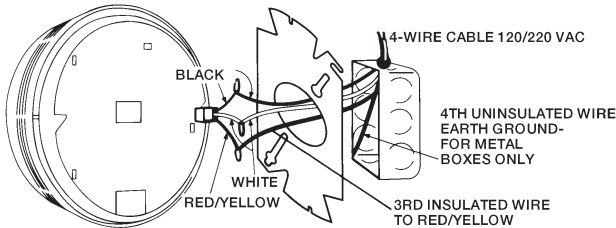

### NOTES ON TANDEM INTERCONNECTING MODELS

- DO NOT connect Gentex smoke alarms to other manufacturers' smoke alarms.
- No more than 12 Gentex models 9123, 9123T, 9123H, 9223, 9223T or 9223H may be connected in tandem.
- No more than 6 Gentex models 9123F, 9123TF, 9123HF, 9223F, 9223TF, 9223HF may be connected in tandem.
- All units connected in tandem **MUST** get their power from the same circuit, that is, all smoke alarms in tandem must be controlled by the same fuse or circuit breaker.
- After installation to verify proper working conditions all horns must sound in this system.

**NOTICE:** IF ALL INTERCONNECTED ALARMS DO NOT EMIT ALARM SIGNAL DURING COMMISSIONING TEST, REFER TO "WIRING TWO OR MORE SMOKE ALARMS" SECTION TO INSURE ALARM WIRING IS IN ACCORDANCE WITH TANDEM WIRING DIGRAM.

**CAUTION:** Failure to observe any of the conditions set forth may cause system malfunction and damage to the smoke alarm.

### BATTERY INSTALLATION

- Remove smoke alarm from mounting plate by turning counter-clockwise.
- Remove AC power connector and unsnap power leads from top of the old battery. Snap new battery onto snaps and reinsert battery through hole in back of smoke alarm.
- Use only Duracell® MN 1604 battery with the 9000 Series smoke alarms. Available at many retail stores.

**CAUTION:** Units with battery back-up will not provide power or transmit an alarm to AC only units in the event of an AC power failure. All battery back-up units in tandem with good batteries will operate normally during an AC power failure for a minimum of 24 hours.

## MOUNTING: PLATE & SMOKE ALARM

- Lace the connector through the provided mounting plate and secure the plate to the junction box.
- Plug the wire connector into the smoke alarm base.

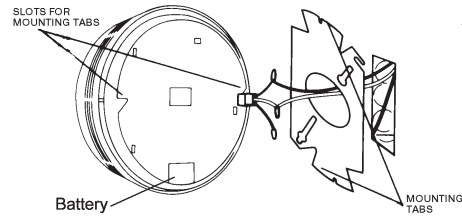

- Place smoke alarm up to mounting plate, rotating it clockwise until smoke alarm firmly snap locks into place. Keep smoke alarm parallel to mounting plate so upper and lower tabs on plate seat correctly into smoke alarm.

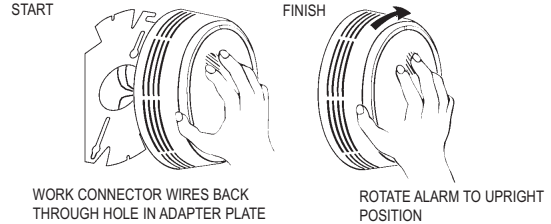

## CHECKOUT & TROUBLESHOOTING

- Turn test knob to NORMAL position and install battery and then supply house power to smoke alarm. The red indicator light should flash every 15-30 seconds, showing smoke alarm is operating properly.
- If red light is not flashing or the green LED is not on:
  - Check that the battery is installed.
  - Check the connector plug and wire connections. NOTE: Be sure you turn off power before checking wire connections.
  - If power supply and wiring check out, but red light does not flash or green LED is still off, return the smoke alarm to manufacturer. See TO RETURN A SMOKE ALARM.
  - When powering up smoke alarms in a tandem installation and all smoke alarms sound immediately, inspect all smoke alarms for those with an illuminated indicator light. These will be the trouble units.
- Testing with Test Knob:
  - Rotate test knob counter-clockwise to TEST 1 position and wait up to 20 seconds for smoke alarm to sound. If smoke alarm does not sound after 20 seconds, return smoke alarm for service.
  - After successfully testing smoke alarm, return test knob to NORMAL (non-test) position and wait 20 seconds for alarm to stop sounding.

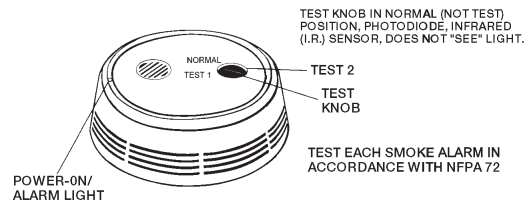

- To test smoke alarm for high sensitivity, turn test knob clockwise to TEST 2 position. Alarm should remain silent.
- Make sure to return test knob back to its normal position.
- If your smoke alarm sounds during this test it means the smoke alarm's sensitivity has become too high and may cause false alarms.
- This could mean your smoke alarm is dirty and should be cleaned as described in the maintenance procedure below.
- If the smoke alarm continues to alarm, for TEST 2 position following cleaning, return it to Gentex for service.
- To check for proper smoke entry into your smoke alarm's sensing chamber, Gentex recommends using the Home Safeguard Smoke Spray or CHEKKIT® SMOKE Detector Tester from SDI.
- This test should be performed once a year and should be sprayed from a distance no closer than 12 inches from the smoke alarm.

## MAINTENANCE

After your smoke alarm has been in operation for a period of time or if it was installed prior to the completion of all building construction, your device may become more sensitive due to dirt build-up in the smoke alarm's optic sensing chamber which could cause nuisance alarms or could cause activation from small amounts of smoke build-up.

If this should occur, following this simple washing procedure will restore your smoke alarm back to its original condition.

For further information, regarding frequency of cleaning and testing, refer to NFPA 72, NFPA, Batterymarch Park, Quincy, MA 02269.

**NOTICE: FAILURE TO FOLLOW FULL CLEANING INSTRUCTIONS COULD RESULT IN DAMAGE TO THIS SMOKE ALARM. DO NOT REMOVE ALL SMOKE ALARMS AT THE SAME TIME FOR CLEANING.**

1. Turn off electrical power to the smoke alarm.
2. Rotate the smoke alarm counter-clockwise to remove it from its mounting plate.
3. Unplug the connector from the back of the smoke alarm. Do not remove the wire connection; leave the connector for your replacement smoke alarm or jumper plug. Remove the battery.
4. Select three (3) standard size wash buckets and fill them each with one gallon of normal tap water (**distilled or de-ionized treated water is recommended as a final rinse if water is extremely hard in your area**).
5. Add 1/8 cup of Ivory® dishwashing liquid to the first bucket of water and allow it to mix thoroughly, then place one dirty smoke alarm into the soap water mixture until it becomes completely covered or submerged.

### NOTICE:

- IF THE SMOKE ALARMS ARE EXCEPTIONALLY DIRTY, YOU MAY WISH TO FIRST WIPE OFF ANY EXCESS DIRT BEFORE WASHING UNIT SO AS NOT TO DIRTY THE WASH WATER TOO QUICKLY.
  - DO NOT OPEN SMOKE ALARM FOR CLEANING. IF SMOKE ALARM IS OPENED DURING CLEANING, PRODUCT WARRANTY BECOMES VOID.
  - ONLY IVORY® DISHWASHING LIQUID IS TO BE USED. OTHER BRANDS ARE NOT RECOMMENDED AND MAY CAUSE YOUR SMOKE ALARM TO MALFUNCTION.
6. Allow smoke alarm to soak for approximately 10 minutes (longer if extremely dirty). Then agitate for 5 or 10 seconds to flush out any remaining dirt left inside smoke alarm's housing.
  7. Remove smoke alarm from wash water and transfer directly to one of the first rinse buckets containing clear water. Again, allow smoke alarm to become completely submerged, agitate once more for 5 or 10 seconds to remove soap residue.
  8. Finally, transfer smoke alarm to your second and final rinse bucket, repeating method found in Step 7, then remove smoke alarm to a clean dry area for a period of 48 hours to allow it to thoroughly dry.

**NOTICE: SMOKE ALARMS ARE TO BE AIR DRIED ONLY. DO NOT PLACE ALARM IN OVEN, MICROWAVE OR USE A HOT AIR BLOWER TO ACCELERATE DRYING TIME. THIS COULD RESULT IN DAMAGE TO YOUR SMOKE ALARM.**

It is recommended to change wash and rinse water after five (5) smoke alarms. If your smoke alarms are extremely dirty, water should be changed more frequently.

In the event you experience difficulty in the cleaning of your smoke alarm or if you have any questions, please contact Gentex Corporation.

Gentex recommends smoke alarms be tested a minimum of once a week. The test feature of your smoke alarm accurately simulates smoke.

### NOTICE:

- IF THE SMOKE ALARM DOES NOT WORK PROPERLY, DO NOT TRY AND FIX IT YOURSELF. THIS WILL VOID YOUR WARRANTY. SEE "TO RETURN A SMOKE ALARM" FOR INSTRUCTIONS TO RETURN SMOKE ALARMS THAT DO NOT OPERATE PROPERLY. DO NOT TRY TO FIX IT YOURSELF.
- NEVER USE AN OPEN FLAME OF ANY KIND TO TEST YOUR SMOKE ALARM. YOU MAY IGNITE AND DAMAGE THE SMOKE ALARM AS WELL AS YOUR HOME. THE TEST FEATURE OF YOUR SMOKE ALARM ACCURATELY SIMULATES SMOKE CONDITIONS AND TESTS THE SMOKE ALARM'S FUNCTIONS AS REQUIRED BY ANSI/UL 217.
- DO NOT COVER, TAPE, OR OTHERWISE BLOCK THE OPENINGS OF YOUR SMOKE ALARM. THESE OPENINGS ARE DESIGNED TO ALLOW AIR TO PASS THROUGH YOUR SMOKE ALARM, THUS SAMPLING THE AIR AROUND THE SMOKE ALARM.
- SMOKE ALARMS ARE NOT TO BE USED WITH DETECTOR GUARDS UNLESS THE COMBINATION HAS BEEN EVALUATED AND FOUND SUITABLE FOR THAT PURPOSE.
- FAILURE TO REGULARLY CLEAN THIS SMOKE ALARM WILL RESULT IN FALSE ALARMS. A BUILD UP OF DUST CREATES AN OBSCURATION THAT SIMULATES SMOKE. THIS MEANS THE UNIT WILL GO INTO ALARM WITHOUT A FIRE CONDITION.

## TO RETURN A SMOKE ALARM

Should you experience problems with your smoke alarm, proceed as follows:

1. Turn off electrical power to the smoke alarm.
2. Twist the smoke alarm counter-clockwise to remove it from its mounting plate.
3. Unplug the connector from the back of the smoke alarm. Do not remove the wire connection; leave the connector for your replacement smoke alarm.
4. Remove battery from smoke alarm. Do not ship smoke alarm with battery still attached to battery clip.
5. Carefully pack (the manufacturer cannot be responsible for consequential damage) and return to the manufacturer. Include complete details as to exact nature of difficulties being experienced and date of installation.
6. Return to: Gentex Corporation, 10985 Chicago Drive, Zeeland, Michigan 49464. Prior to returning, call Gentex at 1-800-436-8391 or e-mail FP\_RMA@gentex.com to obtain a RMA Number from our return department.

## LIMITED WARRANTY

For a period of 12 months from the date of purchase or a maximum of 18 months from the date of manufacture (or as long as required by applicable law), Gentex warrants to you the original purchaser that your appliance will be free from defects in workmanship and materials under normal use and service.

**This warranty does not apply and is void if damage or failure is caused by: accident, abuse, misuse, abnormal use, faulty installation, liquid contact, fire, earthquake or other external cause; operating the appliance outside Gentex's published guidelines; or service, alteration, maintenance or repairs performed by anyone other than Gentex. This warranty also does not apply to: consumable parts, such as batteries; cosmetic damage, including but not limited to scratches or dents; defects caused by normal wear and tear or otherwise due to the normal aging of the appliance, or if any serial number has been removed or defaced from the appliance.**

TO THE EXTENT PERMITTED BY LAW, THIS WARRANTY AND THE REMEDIES SET FORTH HEREIN ARE EXCLUSIVE AND IN LIEU OF ALL OTHER WARRANTIES, REMEDIES AND CONDITIONS, WHETHER ORAL, WRITTEN, STATUTORY, EXPRESS OR IMPLIED. GENTEX DISCLAIMS ALL STATUTORY AND IMPLIED WARRANTIES, INCLUDING WITHOUT LIMITATION, WARRANTIES OF MERCHANTABILITY AND FITNESS FOR A PARTICULAR PURPOSE AND WARRANTIES AGAINST HIDDEN OR LATENT DEFECTS TO THE EXTENT PERMITTED BY LAW. TO THE EXTENT SUCH WARRANTIES CANNOT BE DISCLAIMED, SUCH IMPLIED WARRANTIES SHALL APPLY ONLY FOR THE WARRANTY PERIOD SPECIFIED ABOVE. PLEASE NOTE THAT SOME STATES (COUNTRIES AND PROVINCES) DO NOT ALLOW LIMITATION ON HOW LONG AN IMPLIED WARRANTY (OR CONDITION) LASTS. SO THE ABOVE LIMITATION MAY NOT APPLY TO YOU.

EXCEPT AS PROVIDED IN THIS WARRANTY AND TO THE EXTENT PERMITTED BY LAW, GENTEX WILL NOT BE LIABLE FOR ANY DIRECT, SPECIAL, INCIDENTAL OR CONSEQUENTIAL DAMAGES RESULTING FROM ANY BREACH OF WARRANTY OR CONDITION, OR ARISING IN CONNECTION WITH THE SALE, USE OR REPAIR OF THE APPLIANCE, OR UNDER ANY OTHER LEGAL THEORY, INCLUDING BUT NOT LIMITED TO LOSS OF USE, LOSS OF REVENUE, LOSS OF ACTUAL OR ANTICIPATED PROFITS, LOSS OF THE USE OF MONEY, LOSS OF BUSINESS, LOSS OF OPPORTUNITY, LOSS OF GOODWILL, AND LOSS OF REPUTATION. THE MAXIMUM LIABILITY OF GENTEX SHALL NOT IN ANY CASE EXCEED THE PURCHASE PRICE PAID BY YOU FOR THE APPLIANCE. PLEASE NOTE THAT SOME STATES (COUNTRIES AND PROVINCES) DO NOT ALLOW THE EXCLUSION OR LIMITATION OF INCIDENTAL OR CONSEQUENTIAL DAMAGES, SO THE ABOVE LIMITATION OR EXCLUSION MAY NOT APPLY TO YOU.

If a defect in workmanship or materials causes your appliance to become inoperable within the warranty period, you must return the appliance to Gentex postage prepaid to: Gentex Corporation, 10985 Chicago Dr., Zeeland MI 49464. You must prove to the satisfaction of Gentex the date of purchase of your appliance. You must also enclose a return address. Warranty service may only be performed by Gentex personnel at Gentex's facilities in Zeeland, Michigan. You must also pack the appliance to minimize the risk of it being damaged in transit. If we receive an appliance in a damaged condition as the result of shipping, we will notify you and you must seek a claim with the shipper.

If you submit a valid claim to Gentex during the warranty period, Gentex will, at its option, repair your appliance or furnish you with a new or rebuilt appliance without charge to you except for postage required to return the appliance to us. Gentex will not reimburse you for repairs or replacement parts provided by other parties. Your repaired or replacement appliance will be returned to you free of charge and it will be covered under the warranty for the balance of the warranty period, if any. When a product or part is replaced, any replacement item becomes your property and the replaced item becomes property of Gentex. For additional warranty and product information go to [www.gentex.com](http://www.gentex.com).

**THIS WARRANTY GIVES YOU SPECIFIC LEGAL RIGHTS AND YOU MAY ALSO HAVE OTHER RIGHTS WHICH VARY FROM STATE TO STATE (OR BY COUNTRY OR PROVINCE). BY THIS WARRANTY, GENTEX DOES NOT LIMIT OR EXCLUDE YOUR RIGHTS EXCEPT AS ALLOWED BY LAW. TO FULLY UNDERSTAND YOUR RIGHTS, YOU SHOULD CONSULT THE LAWS OF YOUR COUNTRY, PROVINCE OR STATE.**

### Important Notice:

These materials have been prepared by Gentex Corporation ("Gentex") for informational purposes only, are necessarily summary, and are not purported to serve as legal advice and should not be used as such. Gentex makes no representations and warranties, express or implied, that these materials are complete and accurate, up-to-date, or in compliance with all relevant local, state and federal laws, regulations and rules. The materials do not address all legal considerations as there is inevitable uncertainty regarding interpretation of laws, regulations and rules and the application of such laws, regulations and rules to particular fact patterns. Each person's activities can differently affect the obligations that exist under applicable laws, regulations or rules. Therefore, these materials should be used only for informational purposes and should not be used as a substitute for seeking professional legal advice. Gentex will not be responsible for any action or failure to act in reliance upon the information contained in this material.

GENTEX CORPORATION  
10985 CHICAGO DRIVE, ZEELAND, MI 49464  
PHONE: 1-800-436-8391/ 616-392-7195  
[www.gentex.com](http://www.gentex.com)

550-0093-XAC

Manual Issue Date:  
01/01/93